

4A1 A16400402A1  
CAP ASM.

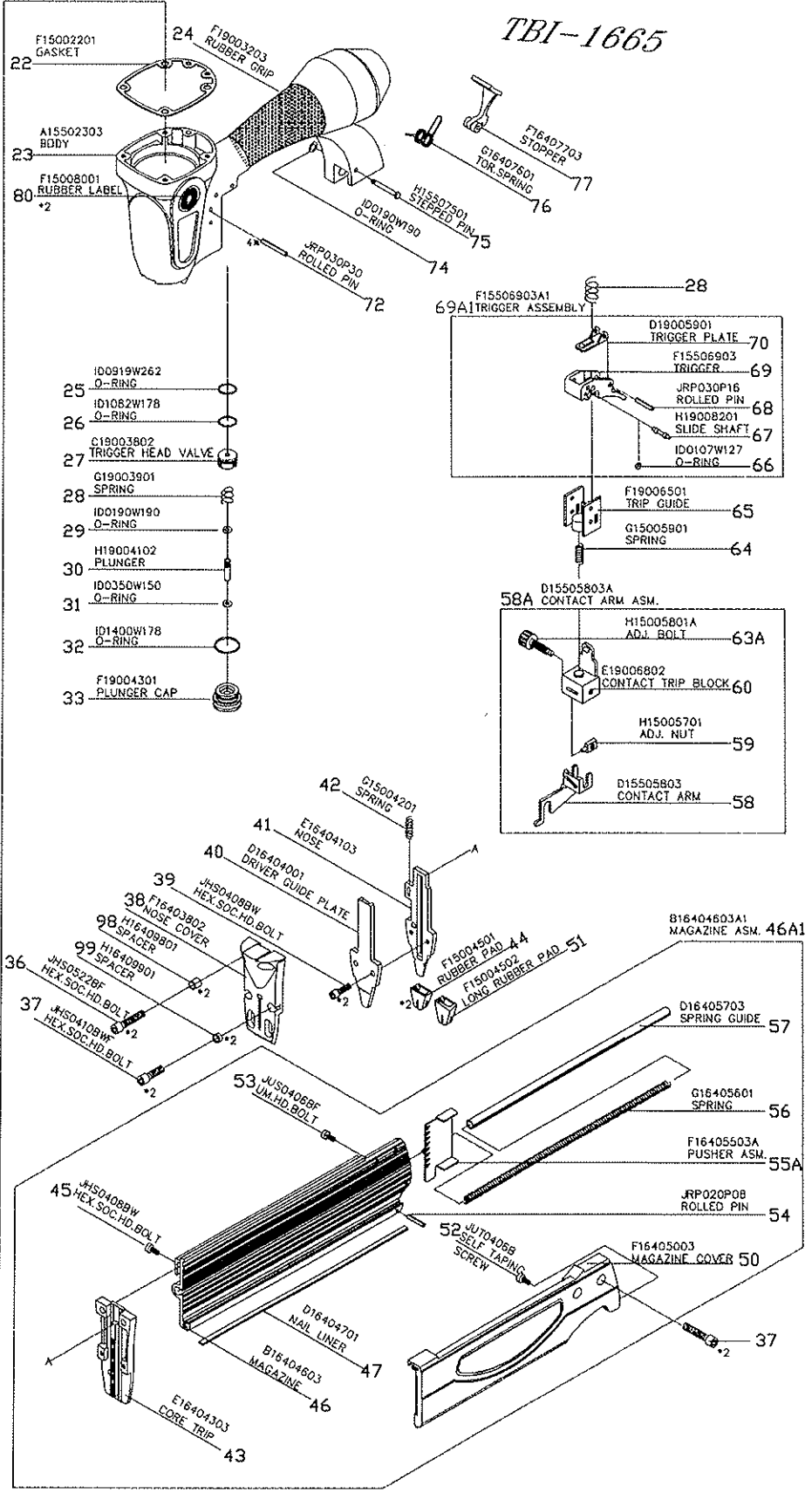
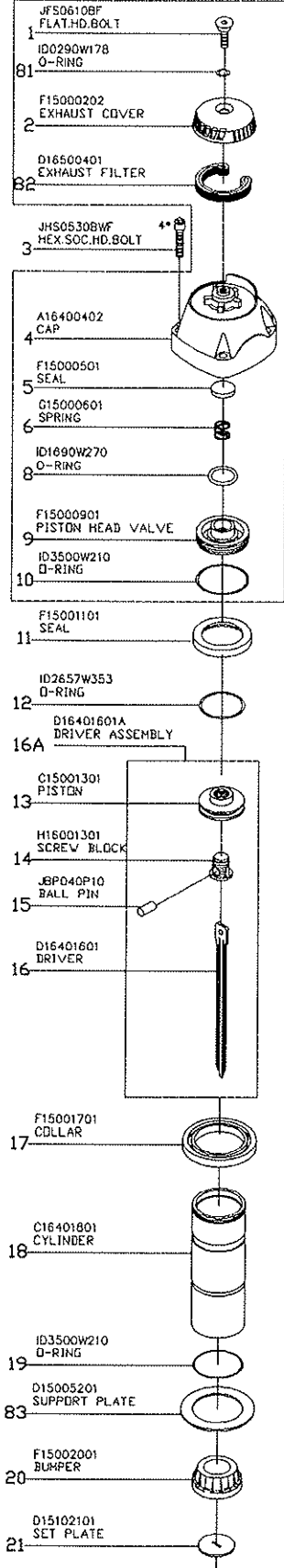

TBI-1665